



PVA10

Robuuste, pneumatisch bediende 2-weg RVS vrijstroomafsluiter in dubbelwerkende en enkelwerkende uitvoering.

DOORLAAT

DN10 (3/8") tot DN80 (3")

AANSLUITING

- 2-Zijdig Binnendraad volgens UNI EN 10226 (DIN ISO 7/1)
- 1/8" gasdraad t.b.v. stuurventiel

DOORSTROMINGSRICHTING

Zie symbool. Standaard is Enkelwerkend Normaal gesloten NC

Afhankelijk medium:

Gassen boven de zitting.

Vloeistoffen onder de zitting.

Maximale viscositeit: ~600 cStokes (mm²/s)

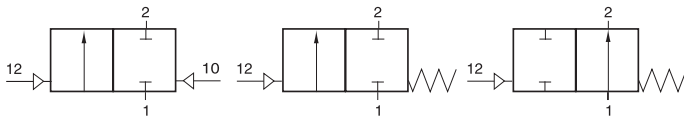

BEDRIJFSDRUK

PN16

TEMPERATUUR BEREIK

Medium

Van -10° tot 200° C

Van -25° tot 220° C

Omgeving

Van -10° tot 80°C

MATERIALEN

Huis: RVS316 (CF8M)

Huisafdichting: PTFE

Afdichting zitting: PTFE

Spindel: RVS316

Afdichting spindel: PTFE

Stuurkop: RVS 304(CF8) of Aluminium

Zuiger: Aluminium

Zuiger afdichting: FPM

MONTAGE

Raadpleeg aanbeveling voor inbouw industriële afsluiters.

MEDIUM

Neutrale gassen en vloeistoffen. Voor toepassingen met agressieve media bestendigheidstabel raadplegen.

BEDIENING (Standaard)

Lucht

dubbelwerkende of enkelwerkende (Veer sluitend "NC" of veer openend "NO") uitvoering.

STUURMEDIUM

Gefilterde lucht volgens PNEUROP/ISO klasse 4, ander stuurmedia op aanvraag

STUURDRUK

- 3 bar min. - 8 bar maximaal bij dubbelwerkende uitvoering.

PNEUMATISCHE AANSTUURING

Optioneel naar gelang uitvoering met een

3/2, 5/2-weg magneetventiel met NAMUR-aansluiting

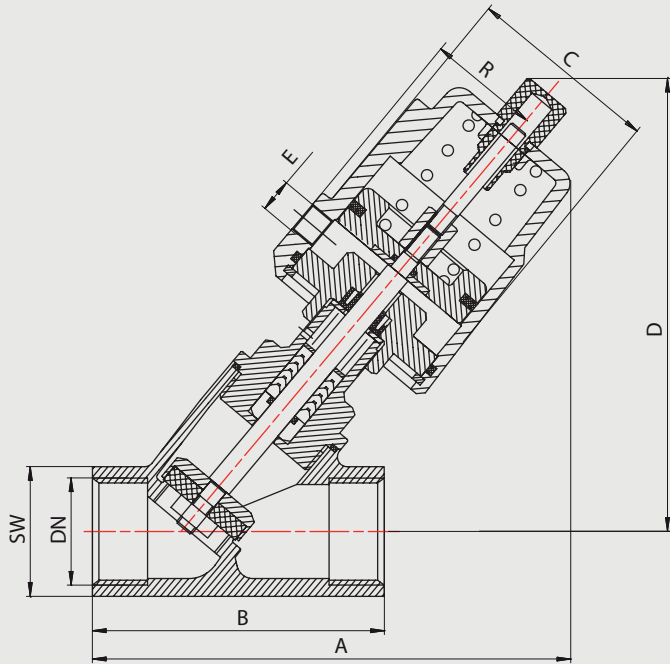

Dubbelwerkende vrijstroomafsluiter met gasdraad, PTFE, Aanstroming onder de zitting
Aanstroming onder de zitting NC

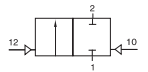

Doorlaat[mm] aansluiting[mm]		max. druk [bar] PN	Stuur- druk	Actu- ator	Druk [bar]	Kv	Inbouwmaat [mm] en gewicht [kg]							Bestelcode	
DN	Rp						A	B	Ø C	D	SW	E	R		Gewicht
10	3/8	16	> 3	40	0-16	5,2	124	68	50,5	112	27	G1/8	27	0,80	3PVA10300010040W
10	3/8	16	> 3	50	0-16	5,2	135	68	60	125	27	G1/8	33	1,00	3PVA10300010050W
15	1/2	16	> 3	40	0-16	6,3	124	68	50,5	112	27	G1/8	27	1,50	3PVA10300015040W
15	1/2	16	> 3	50	0-16	6,3	135	68	60	125	27	G1/8	33	1,92	3PVA10300015050W
20	3/4	16	> 3	50	0-16	11,5	140	75	60	132	32	G1/8	33	3,06	3PVA10300020050W
25	1	16	3-6	50	0-13	20,6	150	90	60	136	40	G1/8	33	3,76	3PVA10300025050W
25	1	16	3-4	63	0-16	20,6	172	90	75	162	40	G1/8	41	4,71	3PVA10300025063W
25	1	16	2-3	90 Al	0-16	20,6	215	90	112	210	40	G1/8	57	4,71	3PVA10300025090AW
25	1	16	2-3	90	0-16	20,6	216	90	106	211	40	G1/8	55	4,71	3PVA10300025090W
32	1.1/4	16	3-6	63	0-16	30,3	190	116	75	174	50	G1/8	41	4,71	3PVA10300030063W
32	1.1/4	16	2-4	90 Al	0-16	30,3	230	116	112	220	50	G1/8	55	4,71	3PVA10300030090AW
32	1.1/4	16	2-4	90	0-16	30,3	235	116	106	223	50	G1/8	41	4,71	3PVA10300030090W
40	1.1/2	16	3-7	63	0-16	42,3	190	116	75	175	56	G1/8	57	4,71	3PVA10300035063W
40	1.1/2	16	2-5	90 Al	0-16	42,3	230	116	112	220	56	G1/8	55	4,71	3PVA10300035090AW
40	1.1/2	16	2-5	90	0-16	42,3	235	116	106	223	56	G1/8	41	4,71	3PVA10300035090W
50	2	16	3-7	63	0-8	60,7	205	138	75	183	69	G1/8	57	4,71	3PVA10300040063W
50	2	16	2-6	90 Al	0-16	60,7	245	138	112	232	69	G1/8	55	4,71	3PVA10300040090AW
50	2	16	2-6	90	0-16	60,7	250	138	106	232	69	G1/8	74	4,71	3PVA10300040090W
50	2	16	2-4	125 Al	0-16	60,7	294	138	145	287	69	G1/8	57	4,71	3PVA103000401250W
65	2.1/2	16	2-7	90	0-11	90,5	282	178	112	262	85	G1/8	55	4,71	3PVA10300045090AW
65	2.1/2	16	2-7	90	0-11	90,5	285	178	106	265	85	G1/8	74	4,71	3PVA10300045090W
65	2.1/2	16	2-5,5	125 Al	0-16	90,5	320	178	148	302	85	G1/8	74	4,71	3PVA10300045125AW

Doorlaat[mm] aansluiting[mm]		max. druk [bar] PN	Stuur- druk	Actu- ator	Druk [bar]	Kv	Inbouwmaat [mm] en gewicht [kg]								Bestelcode
DN	Rp						A	B	Ø C	D	SW	E	R	Gewicht	
80	3	16	2-6,5	125 Al	0-16	135,1	372	210	148	313	100	G1/8	74	4,71	3PVA10300050125AW

Dubbelwerkende vrijstroomafsluiter met gasdraad, PTFE, Aanstroming boven de zitting
Aanstroming boven de zitting NC

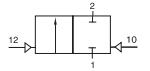

Doorlaat[mm] aansluiting[mm]		max. druk [bar] PN	Stuur- druk	Actu- ator	Druk [bar]	Kv	Inbouwmaat [mm] en gewicht [kg]								Bestelcode
DN	Rp						A	B	Ø C	D	SW	E	R	Gewicht	
10	3/8	16	3-4,5	40	0-16	5,2	124	68	50,5	112	27	G1/8	27	0,80	3PVA10300010040Y
10	3/8	16	3-3,5	50	0-16	5,2	135	68	60	125	27	G1/8	33	1,00	3PVA10300010050Y
15	1/2	16	3-4,5	40	0-16	6,3	124	68	50,5	112	27	G1/8	27	1,50	3PVA10300015040Y
15	1/2	16	3-3,5	50	0-16	6,3	135	68	60	125	27	G1/8	33	1,92	3PVA10300015050Y
20	3/4	16	3-4	50	0-16	11,5	140	75	60	132	32	G1/8	33	3,06	3PVA10300020050Y
25	1	16	3-4,5	50	0-16	20,6	150	90	60	136	40	G1/8	33	3,76	3PVA10300025050Y
25	1	16	3-3,5	63	0-16	20,6	172	90	75	162	40	G1/8	41	4,71	3PVA10300025063Y
25	1	16	3-3,5	90 Al	0-16	20,6	215	90	112	210	40	G1/8	57	4,71	3PVA10300025090AY
25	1	16	2-2,5	90	0-16	20,6	216	90	106	211	40	G1/8	55	4,71	3PVA10300025090Y
32	1.1/4	16	3-5,5	63	0-16	30,3	190	116	75	174	50	G1/8	41	4,71	3PVA10300030063Y
32	1.1/4	16	2-3,5	90 Al	0-16	30,3	230	116	112	220	50	G1/8	55	4,71	3PVA10300030090AY
32	1.1/4	16	2-3,5	90	0-16	30,3	235	116	106	223	50	G1/8	41	4,71	3PVA10300030090Y
40	1.1/2	16	3-6,5	63	0-16	42,3	190	116	75	175	56	G1/8	57	4,71	3PVA10300035063Y
40	1.1/2	16	2-4	90 Al	0-16	42,3	230	116	112	220	56	G1/8	55	4,71	3PVA10300035090AY
40	1.1/2	16	2-4	90	0-16	42,3	235	116	106	223	56	G1/8	41	4,71	3PVA10300035090Y
50	2	16	3-7	63	0-9	60,7	205	138	75	183	69	G1/8	57	4,71	3PVA10300040063Y
50	2	16	2,5-4,5	90 Al	0-16	60,7	245	138	112	232	69	G1/8	55	4,71	3PVA10300040090AY
50	2	16	2,5-4,5	90	0-16	60,7	250	138	106	232	69	G1/8	74	4,71	3PVA10300040090Y
50	2	16	2-3	125 Al	0-16	60,7	294	138	145	287	69	G1/8	57	4,71	3PVA103000401250Y
65	2.1/2	16	2-6	90	0-16	90,5	282	178	112	262	85	G1/8	55	4,71	3PVA10300045090AY
65	2.1/2	16	2-6	90	0-16	90,5	285	178	106	265	85	G1/8	74	4,71	3PVA10300045090Y
65	2.1/2	16	2-4	125 Al	0-16	90,5	320	178	148	302	85	G1/8	74	4,71	3PVA10300045125AY
80	3	16	2-7	125 Al	0-16	135,1	372	210	148	313	100	G1/8	74	4,71	3PVA10300050125AY

Enkelwerkende vrijstroomafsluiter met gasdraad, PTFE, NC, Aanstroming onder de zitting
Aanstroming onder de zitting NC

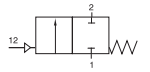

Doorlaat[mm] aansluiting[mm]		max. druk [bar] PN	Stuur- druk	Actu- ator	Druk [bar]	Kv	Inbouwmaat [mm] en gewicht [kg]								Bestelcode
DN	Rp						A	B	Ø C	D	SW	E	R	Gewicht	
10	3/8	16	3	40	0-11	5,2	124	68	50,5	112	27	G1/8	27	0,80	3PVA10300110040W
10	3/8	16	4,5	50	0-14	5,2	135	68	60	125	27	G1/8	33	1,00	3PVA10300110050W
15	1/2	16	3	40	0-11	6,3	124	68	50,5	112	27	G1/8	27	1,50	3PVA10300115040W
15	1/2	16	4,5	50	0-14	6,3	135	68	60	125	27	G1/8	33	1,92	3PVA10300115050W
20	3/4	16	4,5	50	0-14	11,5	140	75	60	132	32	G1/8	33	3,06	3PVA10300120050W
25	1	16	4,5	50	0-7,5	20,6	150	90	60	136	40	G1/8	33	3,76	3PVA10300125050W
25	1	16	5	63	0-14	20,6	172	90	75	162	40	G1/8	41	4,71	3PVA10300125063W
25	1	16	3,5	90 Al	0-14	20,6	215	90	112	210	40	G1/8	57	4,71	3PVA10300125090AW
25	1	16	3,5	90	0-14	20,6	216	90	106	211	40	G1/8	55	4,71	3PVA10300125090W
32	1.1/4	16	5	63	0-6	30,3	190	116	75	174	50	G1/8	41	4,71	3PVA10300130063W
32	1.1/4	16	6	90 Al	0-16	30,3	230	116	112	220	50	G1/8	55	4,71	3PVA10300130090AW
32	1.1/4	16	6	90	0-16	30,3	235	116	106	223	50	G1/8	41	4,71	3PVA10300130090W

Doorlaat[mm] aansluiting[mm]		max. druk [bar] PN	Stuur- druk	Actu- ator	Druk [bar]	Kv	Inbouwmaat [mm] en gewicht [kg]								Bestelcode
DN	Rp						A	B	Ø C	D	SW	E	R	Gewicht	
40	1.1/2	16	5	63	0-5	42,3	190	116	75	175	56	G1/8	57	4,71	3PVA10300135063W
40	1.1/2	16	6	90 AI	0-16	42,3	230	116	112	220	56	G1/8	55	4,71	3PVA10300135090AW
40	1.1/2	16	6	90	0-16	42,3	235	116	106	223	56	G1/8	41	4,71	3PVA10300135090W
50	2	16	5	63	0-3,5	60,7	205	138	75	183	69	G1/8	57	4,71	3PVA10300140063W
50	2	16	6	90 AI	0-13	60,7	245	138	112	232	69	G1/8	55	4,71	3PVA10300140090AW
50	2	16	6	90	0-13	60,7	250	138	106	232	69	G1/8	74	4,71	3PVA10300140090W
50	2	16	6	125 AI	0-16	60,7	294	138	145	287	69	G1/8	57	4,71	3PVA103001401250W
65	2.1/2	16	6	90	0-8	90,5	282	178	112	262	85	G1/8	55	4,71	3PVA10300145090AW
65	2.1/2	16	6	90	0-8	90,5	285	178	106	265	85	G1/8	74	4,71	3PVA10300145090W
65	2.1/2	16	6	125 AI	0-10	90,5	320	178	148	302	85	G1/8	74	4,71	3PVA10300145125AW
80	3	16	6	125 AI	0-2,5	135,1	372	210	148	313	100	G1/8	74	4,71	3PVA10300150125AW

Enkelwerkende vrijstroomafsluiter met gasdraad, PTFE, NC, Aanstroming boven de zitting
Aanstroming boven de zitting

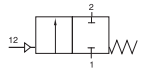

Doorlaat[mm] aansluiting[mm]		max. druk [bar] PN	Stuur- druk	Actu- ator	Druk [bar]	Kv	Inbouwmaat [mm] en gewicht [kg]								Bestelcode
DN	Rp						A	B	Ø C	D	SW	E	R	Gewicht	
10	3/8	16	3-4,5	40	0-16	5,2	124	68	50,5	112	27	G1/8	27	0,80	3PVA10300110040Y
10	3/8	16	3-3,5	50	0-16	5,2	135	68	60	125	27	G1/8	33	1,00	3PVA10300110050Y
15	1/2	16	3-4,5	40	0-16	6,3	124	68	50,5	112	27	G1/8	27	1,50	3PVA10300115040Y
15	1/2	16	3-3,5	50	0-16	6,3	135	68	60	125	27	G1/8	33	1,92	3PVA10300115050Y
20	3/4	16	3-4	50	0-16	11,5	140	75	60	132	32	G1/8	33	3,06	3PVA10300120050Y
25	1	16	3-4,5	50	0-16	20,6	150	90	60	136	40	G1/8	33	3,76	3PVA10300125050Y
25	1	16	3-3,5	63	0-16	20,6	172	90	75	162	40	G1/8	41	4,71	3PVA10300125063Y
25	1	16	3-3,5	90 AI	0-16	20,6	215	90	112	210	40	G1/8	57	4,71	3PVA10300125090AY
25	1	16	2-2,5	90	0-16	20,6	216	90	106	211	40	G1/8	55	4,71	3PVA10300125090Y
32	1.1/4	16	3-5,5	63	0-16	30,3	190	116	75	174	50	G1/8	41	4,71	3PVA10300130063Y
32	1.1/4	16	2-3,5	90 AI	0-16	30,3	230	116	112	220	50	G1/8	55	4,71	3PVA10300130090AY
32	1.1/4	16	2-3,5	90	0-16	30,3	235	116	106	223	50	G1/8	41	4,71	3PVA10300130090Y
40	1.1/2	16	3-6,5	63	0-16	42,3	190	116	75	175	56	G1/8	57	4,71	3PVA10300135063Y
40	1.1/2	16	2-4	90 AI	0-16	42,3	230	116	112	220	56	G1/8	55	4,71	3PVA10300135090AY
40	1.1/2	16	2-4	90	0-16	42,3	235	116	106	223	56	G1/8	41	4,71	3PVA10300135090Y
50	2	16	3-7	63	0-9	60,7	205	138	75	183	69	G1/8	57	4,71	3PVA10300140063Y
50	2	16	2,5-4,5	90 AI	0-16	60,7	245	138	112	232	69	G1/8	55	4,71	3PVA10300140090AY
50	2	16	2,5-4,5	90	0-16	60,7	250	138	106	232	69	G1/8	74	4,71	3PVA10300140090Y
50	2	16	2-3	125 AI	0-16	60,7	294	138	145	287	69	G1/8	57	4,71	3PVA103001401250Y
65	2.1/2	16	2-6	90	0-10	90,5	282	178	112	262	85	G1/8	55	4,71	3PVA10300145090AY
65	2.1/2	16	2-6	90	0-16	90,5	285	178	106	265	85	G1/8	74	4,71	3PVA10300145090Y
65	2.1/2	16	2-4	125 AI	0-16	90,5	320	178	148	302	85	G1/8	74	4,71	3PVA10300145125AY
80	3	16	2-7	125 AI	0-16	135,1	372	210	148	313	100	G1/8	74	4,71	3PVA10300150125AY

Enkelwerkende vrijstroomafsluiter met gasdraad, PTFE, NO, Aanstroming onder de zitting
Aanstroming onder de zitting NC

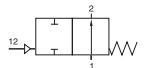

Doorlaat[mm] aansluiting[mm]		max. druk [bar] PN	Stuur- druk	Actu- ator	Druk [bar]	Kv	Inbouwmaat [mm] en gewicht [kg]								Bestelcode
DN	Rp						A	B	Ø C	D	SW	E	R	Gewicht	
10	3/8	16	2-4	50	0-16	3,8	135	68	60	125	27	G1/8	33	1,00	3PVA10300210050W
15	1/2	16	2-4	50	0-16	4,7	135	68	60	125	27	G1/8	33	1,92	3PVA10300215050W

Doorlaat[mm] aansluiting[mm]		max. druk [bar] PN	Stuur- druk	Actu- ator	Druk [bar]	Kv	Inbouwmaat [mm] en gewicht [kg]								Bestelcode
DN	Rp						A	B	Ø C	D	SW	E	R	Gewicht	
20	3/4	16	2-6	50	0-16	9.5	140	75	60	132	32	G1/8	33	3,06	3PVA10300220050W
25	1	16	2-6	50	0-13	18.1	150	90	60	136	40	G1/8	33	3,76	3PVA10300225050W
25	1	16	2,5-5	63	0-16	18.1	172	90	75	162	40	G1/8	41	4,71	3PVA10300225063W
25	1	16	2-4	90 Al	0-16	18.1	215	90	112	210	40	G1/8	57	4,71	3PVA10300225090AW
25	1	16	2-4	90	0-16	18.1	216	90	106	211	40	G1/8	55	4,71	3PVA10300225090W
32	1.1/4	16	2,5-5	63	0-13	23.1	190	116	75	174	50	G1/8	41	4,71	3PVA10300230063W
32	1.1/4	16	2-4	90 Al	0-16	23.1	230	116	112	220	50	G1/8	55	4,71	3PVA10300230090AW
32	1.1/4	16	2-4	90	0-16	23.1	235	116	106	223	50	G1/8	41	4,71	3PVA10300230090W
40	1.1/2	16	2,5-6	63	0-7	32.9	190	116	75	175	56	G1/8	57	4,71	3PVA10300235063W
40	1.1/2	16	3-3,5	90 Al	0-16	32.9	230	116	112	220	56	G1/8	55	4,71	3PVA10300235090AW
40	1.1/2	16	3-3,5	90	0-16	32.9	235	116	106	223	56	G1/8	41	4,71	3PVA10300235090W
50	2	16	2,5-6	63	0-5	52.8	205	138	75	183	69	G1/8	57	4,71	3PVA10300240063W
50	2	16	2,5-6	90 Al	0-12	52.8	245	138	112	232	69	G1/8	55	4,71	3PVA10300240090AW
50	2	16	2,5-6	90	0-12	52.8	250	138	106	232	69	G1/8	74	4,71	3PVA10300240090W
50	2	16	2,5-6	125 Al	0-16	52.8	294	138	145	287	69	G1/8	57	4,71	3PVA103002401250W
65	2.1/2	16	2,5-5	90	0-7,5	82.5	282	178	112	262	85	G1/8	55	4,71	3PVA10300245090AW
65	2.1/2	16	2,5-5	90	0-7,5	82.5	285	178	106	265	85	G1/8	74	4,71	3PVA10300245090W
65	2.1/2	16	2,5-7	125 Al	0-14	82.5	320	178	148	302	85	G1/8	74	4,71	3PVA10300245125AW
80	3	16	2,5-7	125 Al	0-12	127,0	372	210	148	313	100	G1/8	74	4,71	3PVA10300250125AW

Enkelwerkende vrijstroomafsluiter met gasdraad, PTFE, NO, Aanstroming boven de zitting
Aanstroming boven de zitting

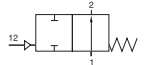

Doorlaat[mm] aansluiting[mm]		max. druk [bar] PN	Stuur- druk	Actu- ator	Druk [bar]	Kv	Inbouwmaat [mm] en gewicht [kg]								Bestelcode
DN	Rp						A	B	Ø C	D	SW	E	R	Gewicht	
10	3/8	16	> 3	50	0-16	3.8	135	68	60	125	27	G1/8	33	1,00	3PVA10300210050Y
15	1/2	16	> 3	50	0-16	4.7	135	68	60	125	27	G1/8	33	1,92	3PVA10300215050Y
20	3/4	16	> 3	50	0-12	9.5	140	75	60	132	32	G1/8	33	3,06	3PVA10300220050Y
25	1	16	> 3	50	0-3	18.1	150	90	60	136	40	G1/8	33	3,76	3PVA10300225050Y
25	1	16	> 4,5	63	0-16	18.1	172	90	75	162	40	G1/8	41	4,71	3PVA10300225063Y
32	1.1/4	16	> 4,5	63	0-14	23.1	190	116	75	174	50	G1/8	41	4,71	3PVA10300230063Y
40	1.1/2	16	> 4,5	63	0-14	32.9	190	116	75	175	56	G1/8	57	4,71	3PVA10300235063Y
50	2	16	> 4,5	63	0-6	52.8	205	138	75	183	69	G1/8	57	4,71	3PVA10300240063Y



Pneumatisch bediende
2-Weg
RVS vrijstroomafsluiter

PVA10