

# 2.4

## Pilot Actuated Valves

Selected valves can be used for technical vacuum too.



Selected models are available for low temperature application.  
For detailed information refer to chapter 2.12.



Selected models can be equipped with FKM seals for high temperature environment up to 120 °C.



Selected models are available in stainless steel.  
For detailed information refer to chapter 2.13.

Selected models are available for explosion hazardous environment.  
For detailed information refer to chapter 2.15.

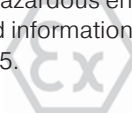

# P 310 302/P 310 502/P 320 302/P 320 502

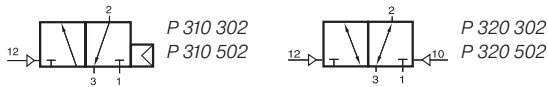

Pneumatically actuated 3/2-way spool valve.

Type P 310:

If pressure is attached to port 1 the function is normally closed.

If pressure is applied to port 3 the function is normally open.

Do not attach pressure at port 2.

Operating pressure and actuating pressure should be at the same level.

Type P 320:

If signal is applied to 12 the valve is open from 1 to 2 and 3 is blocked.

If signal is applied at 10 the valve is open from 2 to 3.

Position is kept until next pneumatic signal is applied.

Version with dominating piston available on request.

Exhaust can be throttled.

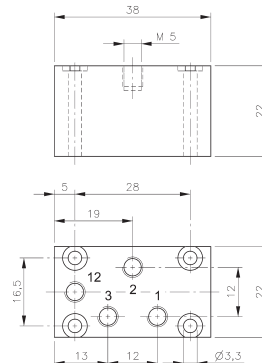

**P 310 302**

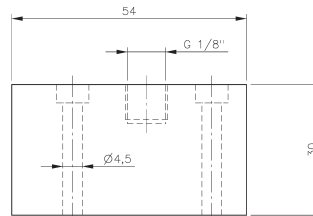

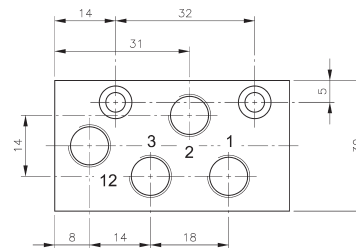

**P 310 502**

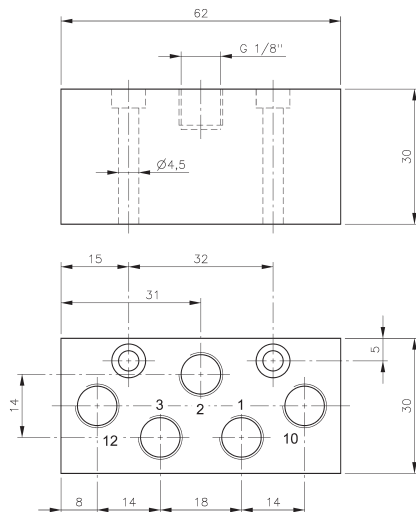

**P 320 302**



**P 320 502**

Type	Port size	Air flow	Operating press.	Actuating press.	Weight
P 310 302	M5	180 l/min	2 - 10 bar	the same	0,05 kg
P 310 502	G 1/8"	650 l/min	2 - 10 bar	the same	0,13 kg 
P 320 302	M5	180 l/min	1 - 10 bar	2,5 - 10 bar	0,05 kg
P 320 502	G 1/8"	650 l/min	1 - 10 bar	2,5 - 10 bar	0,13 kg 

# P 310 501 G/P 310 701 G/P 310 801 P 311 501 G/P 311 701 G/P 311 801

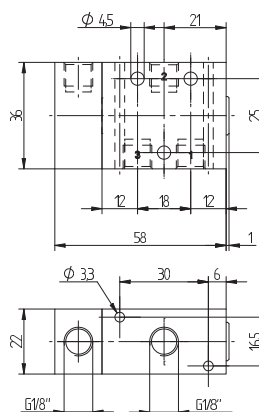
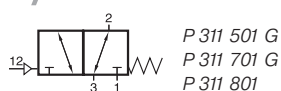
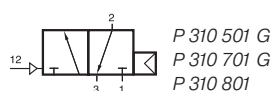

**P 310 501 G/P 311 501 G**

Pneumatically actuated 3/2-way spool valve.

Type P 310 \_\_\_ with air-spring-return.

Operating pressure and actuating pressure should be at the same level.

Type P 311 \_\_\_ with mechanical spring return.

If pressure is attached to port 1 the function is normally closed.  
If pressure is applied to port 3 the function is normally open.  
Pressure can only be attached to port 2 if valve has a mechanical spring (type P 311 \_\_\_).

If 2/2-way is required, please use type P 311 \_\_\_\_. Ports can be fully plugged.

The G-Series valves offer the flexibility of in-line fitment as well as the option of being assembled on to a manifold as shown. Plates are displayed on page 2.7.1.3.

Exhaust can be throttled.

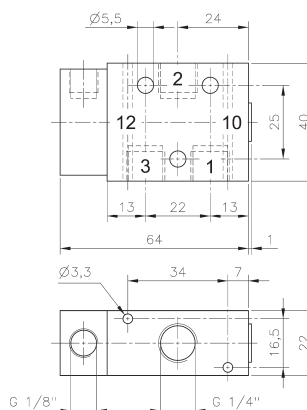

**P 310 701 G/P 311 701 G  
P 310 701 G NPT/ P 311 701 G NPT**

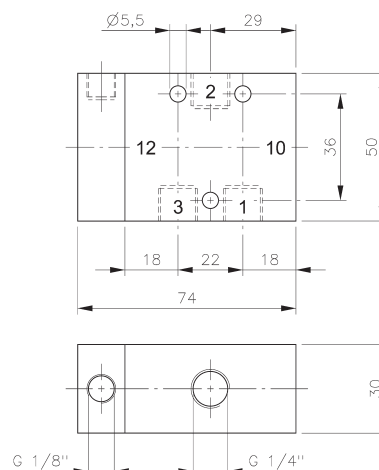

**P 310 801/P 311 801**

Type	Port size	Air flow	Operating press.	Actuating press.	Weight
P 310 501 G	G 1/8"	650 l/min	2 - 10 bar	the same	0,13 kg
P 310 701 G	G 1/4"	1250 l/min	2 - 10 bar	the same	0,14 kg
P 310 801	G 1/4"	1450 l/min	1,5 - 10 bar	the same	0,29 kg
P 311 501 G	G 1/8"	1250 l/min	1 - 10 bar	3 - 10 bar	0,13 kg
P 311 701 G	G 1/4"	1250 l/min	1 - 10 bar	3 - 10 bar	0,14 kg
P 311 801	G 1/4"	1450 l/min	1 - 10 bar	3 - 10 bar	0,29 kg

# P 310 101/P 310 121/P 310 181 P 311 101/P 311 121/P 311 181

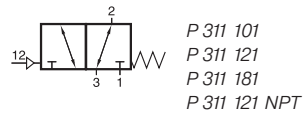
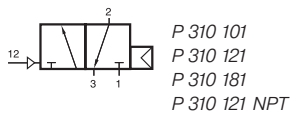

Pneumatically actuated 3/2-way spool valve.

Type P 310 \_\_\_ with air-spring-return.

Operating pressure and actuating pressure should be at the same level. Pressure can be applied to port 1 (NC) or port 2 (NO).

Type P 311 \_\_\_ with mechanical spring return. Pressure can be applied to port 1 (NC), port 2 (NO) or port 3 (switch).

If 2/2-way is required, please use type P 311 \_\_\_\_. Ports can be fully plugged.

Exhaust can be throttled.

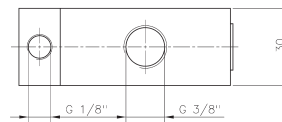
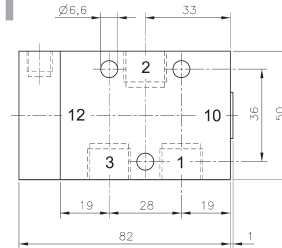

**P 310 101/P 311 101**

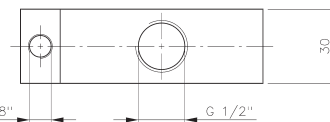
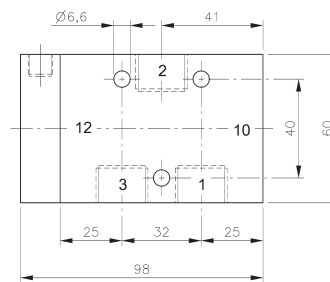

**P 310 121/P 311 121  
P 310 121 NPT/P 311 121 NPT**

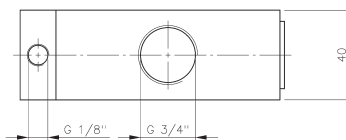
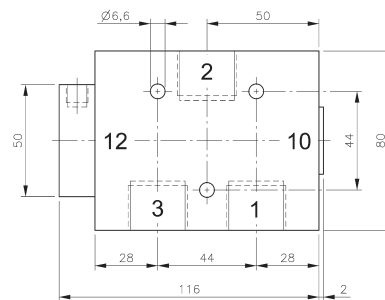

**P 310 181/P 311 181**

Type	Port size	Air flow	Operating press.	Actuating press.	Weight
P 310 101	G 3/8"	2250 l/min	1,5 - 10 bar	the same	0,32 kg
P 310 121	G 1/2"	3000 l/min	1 - 10 bar	the same	0,45 kg
P 310 181	G 3/4"	6000 l/min	1 - 10 bar	the same	0,85 kg
P 311 101	G 3/8"	2250 l/min	1 - 10 bar	3 - 10 bar	0,32 kg
P 311 121	G 1/2"	3000 l/min	1 - 10 bar	3 - 10 bar	0,45 kg
P 311 181	G 3/4"	6000 l/min	1 - 10 bar	3 - 10 bar	0,85 kg
P 310 121 NPT	1/2" NPT	3000 l/min	1 - 10 bar	the same	0,45 kg
P 311 121 NPT	1/2" NPT	3000 l/min	1 - 10 bar	3 - 10 bar	0,45 kg

# P 320 501 G/P 320 701 G/ P 320 801

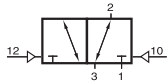

P 320 501 G  
P 320 701 G  
P 320 801

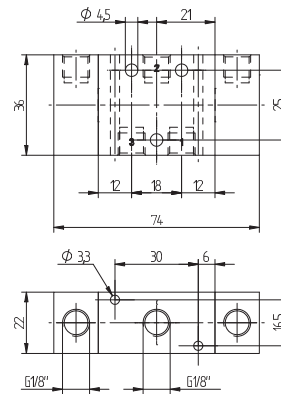

**P 320 501 G**

Pneumatically actuated 3/2-way spool valve actuated by impulse.

If signal is applied to 12 the valve is open from 1 to 2 and 3 is blocked.

If signal is applied at 10 the valve is open from 2 to 3.

The G-Series valves offer the flexibility of in-line fitment as well as the option of being assembled on to a manifold as shown. Plates are displayed on page 2.7.1.3.

Position is kept until next pneumatic signal is applied.

Operating pressure can also be applied to 2.

Exhaust can be throttled.

Versions with dominating piston Type 322 available on request.

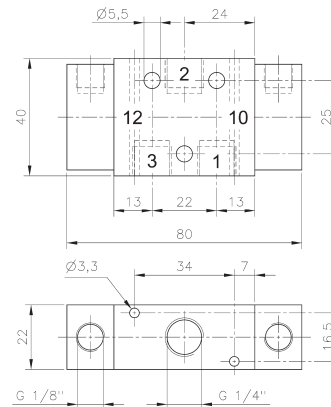

**P 320 701 G**

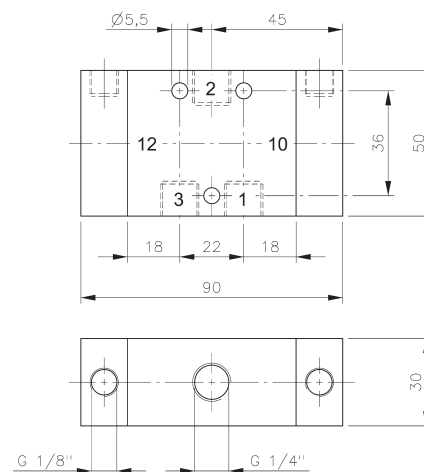

**P 320 801**

Type	Port size	Air flow	Operating press.	Actuating press.	Weight
P 320 501 G	G 1/8"	650 l/min	1 - 10 bar	2,5 - 10 bar	0,16 kg
P 320 701 G	G 1/4"	1250 l/min	1 - 10 bar	2,5 - 10 bar	0,17 kg
P 320 801	G 1/4"	1450 l/min	1 - 10 bar	2,5 - 10 bar	0,34 kg

# P 320 101/P 320 121/P 320 181

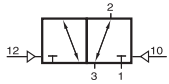

P 320 101  
P 320 121  
P 320 181



Pneumatically actuated 3/2-way spool valve actuated by impulse.

If signal is applied to 12 the valve is open from 1 to 2 and 3 is blocked.

If signal is applied at 10 the valve is open from 2 to 3.

Operating pressure can also be applied to 2.

Position is kept until next pneumatic signal is applied.

Exhaust can be throttled.

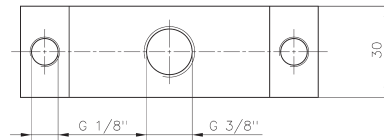
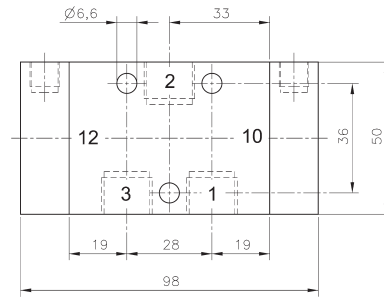

**P 320 101**

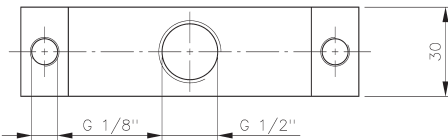
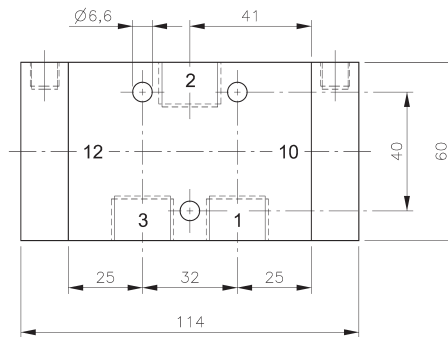

**P 320 121**

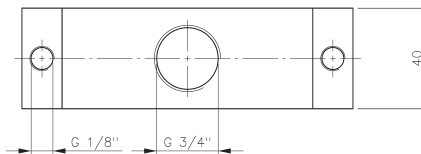
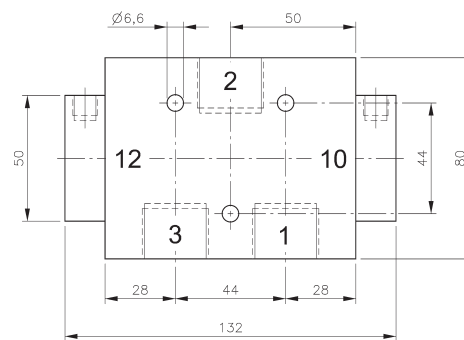

**P 320 181**

Type	Port size	Air flow	Operating press.	Actuating press.	Weight
P 320 101	G 3/8"	2250 l/min	1 - 10 bar	2,5 - 10 bar	0,38 kg
P 320 121	G 1/2"	3000 l/min	1 - 10 bar	2,5 - 10 bar	0,52 kg
P 320 181	G 3/4"	6000 l/min	1 - 10 bar	2 - 10 bar	0,88 kg

# P 510 302/P 510 502/P 520 302/P 520 502

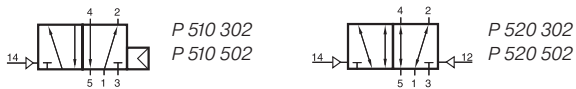

Pneumatically actuated 5/2-way spool valve.

### Type 510:

Actuated by permanent signal and equipped with air spring return.

Normally open from 1 to 2 and from 4 to 5.

If pressure is applied at 14 the valve is open from 1 to 4 and 2 to 3.

Operating pressure and actuating pressure should be at the same level.

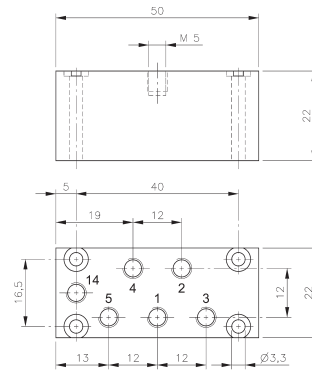

**P 510 302**

### Type 520:

Pneumatically actuated 5/2-way spool valve actuated by impulse.

If signal is applied to 14 the valve is open from 1 to 4 and 2 to 3, 5 is closed.

If signal is applied to 12 the valve is open from 1 to 2 and 4 to 5.

Position is kept until next pneumatic signal is applied.

5/3-way centre closed version type P 531 302 available on request.

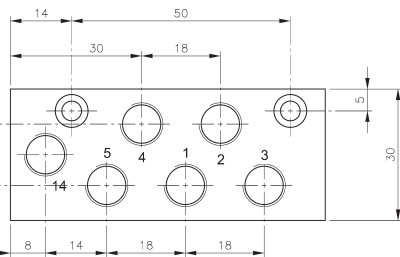
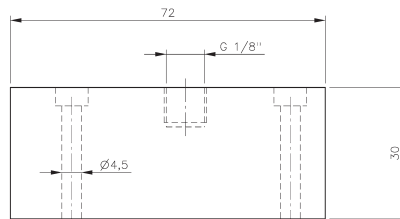
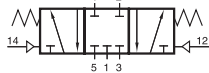

**P 510 502**

Exhaust can be throttled.

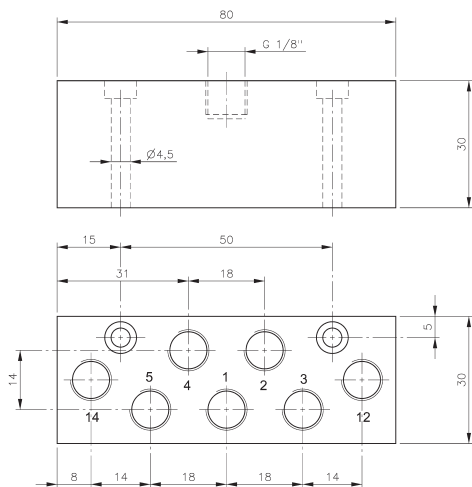

**P 520 502**

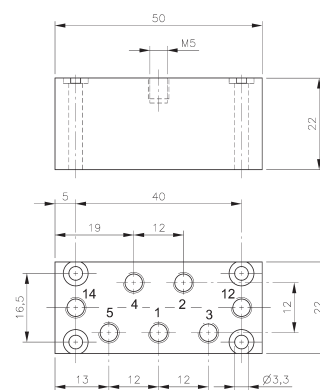

**P 520 302**

Type	Port size	Air flow	Operating press.	Actuating press.	Weight
P 510 302	M5	180 l/min	2 - 10 bar	the same	0,07 kg
P 510 502	G 1/8"	650 l/min	2 - 10 bar	the same	0,17 kg
P 520 302	M5	180 l/min	1 - 10 bar	2 - 10 bar	0,07 kg
P 520 502	G 1/8"	650 l/min	1 - 10 bar	2 - 10 bar	0,17 kg



# P 510 501 G/P 510 701 G/P 510 801 P 511 501 G/P 511 701 G/P 511 801

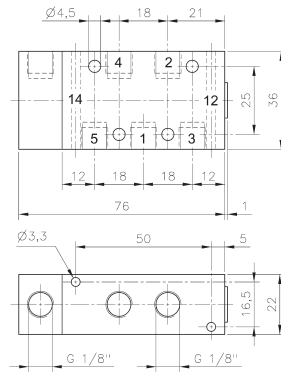
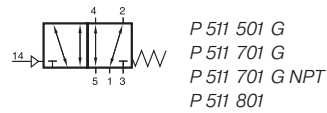
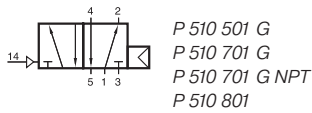

**P 510 501 G/P 511 501 G**

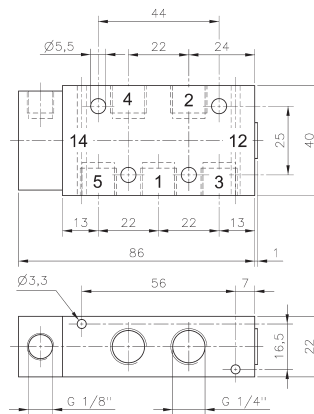

**P 510 701 G/P 511 701 G  
P 501 701 G NPT/P 511 701 G NPT**

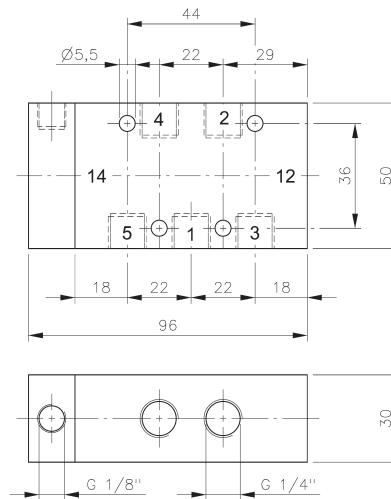

**P 510 801/P 511 801**



Pneumatically actuated 5/2-way spool valve.

Type P 510 \_\_\_ with air-spring-return.

Operating pressure and actuating pressure should be at the same level.

Type P 511 \_\_\_ with mechanical spring return.

Normally open from 1 to 2 and from 4 to 5.

If pressure is applied at 14 the valve is open from 1 to 4 and 2 to 3.

The G-Series valves offer the flexibility of in-line fitment as well as the option of being assembled on to a manifold as shown. Manifolds for valves type 501 G are displayed on page 2.7.2.2, manifolds for valves type 701 G are displayed on page 2.7.2.3.

Exhaust can be throttled.

Type	Port size	Air flow	Operating press.	Actuating press.	Weight
P 510 501 G	G 1/8"	650 l/min	2 - 10 bar	the same	0,16 kg
P 510 701 G	G 1/4"	1250 l/min	2 - 10 bar	the same	0,18 kg
P 510 801	G 1/4"	1450 l/min	1,5 - 10 bar	the same	0,38 kg
P 511 501 G	G 1/8"	650 l/min	1 - 10 bar	3 - 10 bar	0,16 kg
P 511 701 G	G 1/4"	1250 l/min	1 - 10 bar	3 - 10 bar	0,18 kg
P 511 801	G 1/4"	1450 l/min	1 - 10 bar	3 - 10 bar	0,38 kg
P 510 701 G NPT	1/4" NPT	1250 l/min	2 - 10 bar	the same	0,18 kg
P 511 701 G NPT	1/4" NPT	1250 l/min	1 - 10 bar	3 - 10 bar	0,18 kg



# P 510 101/P 510 121/P 510 181 P 511 101/P 511 121/P 511 181

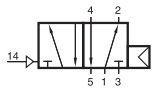

P 510 101  
P 510 121  
P 510 181  
P 510 121 NPT

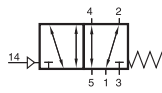

P 511 101  
P 511 121  
P 511 181  
P 511 121 NPT

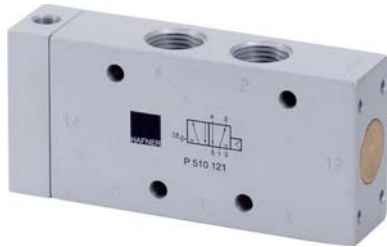

Pneumatically actuated 5/2-way spool valve.

Type P 510 \_\_\_ with air-spring return.  
Operating pressure and actuating pressure should be at the same level.

Type P 511 \_\_\_ with mechanical spring return.

Normally open from 1 to 2 and from 4 to 5.  
If pressure is applied at 14 the valve is open from 1 to 4 and 2 to 3.

Exhaust can be throttled.

Valves type P 510 121 G and P 511 121 G for manifolds displayed on page 2.7.2.5.

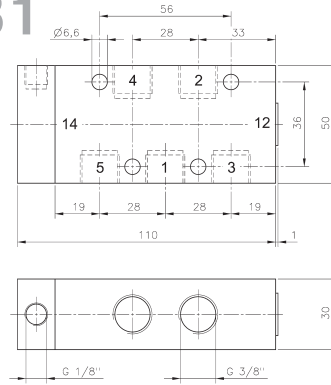

**P 510 101/P 511 101**

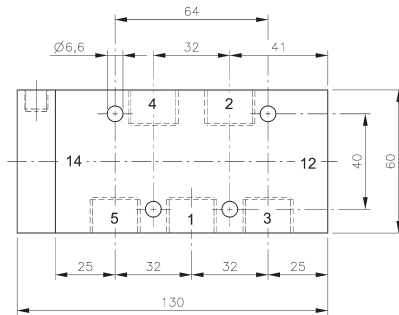

**P 510 121/P 511 121  
P 510 121 NPT/P511 121 NPT**

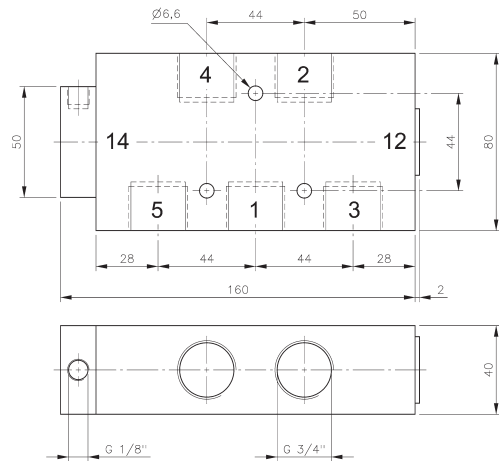

**P 510 181/P 511 181**

Type	Port size	Air flow	Operating press.	Actuating press.	Weight
P 510 101	G 3/8"	2250 l/min	1,5 - 10 bar	the same	0,42 kg
P 510 121	G 1/2"	3000 l/min	1 - 10 bar	the same	0,59 kg
P 510 181	G 3/4"	6000 l/min	1 - 10 bar	the same	1,18 kg
P 511 101	G 3/8"	2250 l/min	1 - 10 bar	3 - 10 bar	0,42 kg
P 511 121	G 1/2"	3000 l/min	1 - 10 bar	3 - 10 bar	0,59 kg
P 511 181	G 3/4"	6000 l/min	1 - 10 bar	3 - 10 bar	1,18 kg
P 510 121 NPT	1/2" NPT	3000 l/min	1 - 10 bar	the same	0,59 kg
P 511 121 NPT	1/2" NPT	3000 l/min	1 - 10 bar	3 - 10 bar	0,59 kg

# P 520 501 G/P 520 701 G/P 520 801 P 522 501 G/P 522 701 G

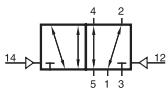

P 520 501 G  
P 520 701 G  
P 520 701 G NPT  
P 520 801

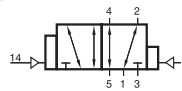

P 522 501 G  
P 522 701 G

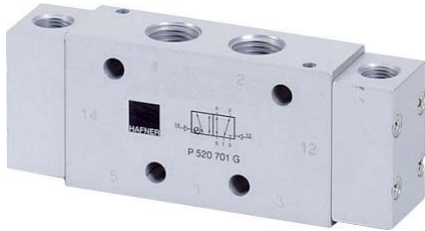

G-Series 501 G/701 G

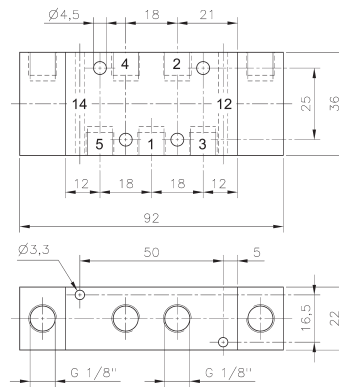

**P 520 501 G/P 522 501 G**

Pneumatically actuated 5/2-way spool valve.

Type P 520 \_\_\_ double pilot  
Type P 522 \_\_\_ double pilot dominating at port 14

If signal is applied to 14 the valve is open from 1 to 4 and 2 to 3, 5 is closed.  
If signal is applied to 12 the valve is open from 1 to 2 and 4 to 5.

Position is kept until next pneumatic signal is applied.

The G-Series valves offer the flexibility of in-line fitment as well as the option of being assembled on to a manifold as shown. Manifolds for valves type 501 G are displayed on page 2.7.2.2, manifolds for valves type 701 G are displayed on page 2.7.2.3.

Exhaust can be throttled.

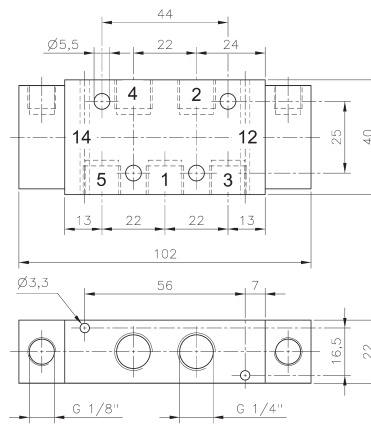

**P 520 701 G/P 522 701 G  
P 520 701 G NPT**

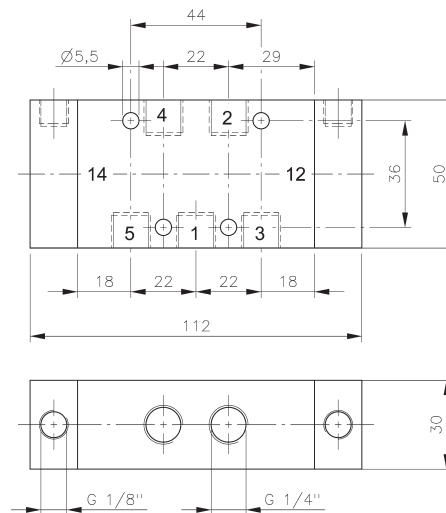

**P 520 801**

Type	Port size	Air flow	Operating press.	Actuating press.	Weight
P 520 501 G	G 1/8"	650 l/min	1 - 10 bar	2 - 10 bar	0,20 kg
P 522 501 G	G 1/8"	650 l/min	1 - 10 bar	2 - 10 bar	0,20 kg
P 520 701 G	G 1/4"	1250 l/min	1 - 10 bar	2 - 10 bar	0,22 kg
P 522 701 G	G 1/4"	1250 l/min	1 - 10 bar	2 - 10 bar	0,22 kg
P 520 801	G 1/4"	1450 l/min	1 - 10 bar	1,5 - 10 bar	0,44 kg
P 520 701 G NPT	1/4" NPT	1250 l/min	1 - 10 bar	2 - 10 bar	0,22 kg

# P 520 101/P 520 121/P 520 181

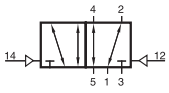

P 520 101  
 P 520 121  
 P 520 181  
 P 520 121 NPT



Pneumatically actuated 5/2-way spool valve actuated by impulse.

If signal is applied to 14 the valve is open from 1 to 4 and 2 to 3, 5 is closed.

If signal is applied to 12 the valve is open from 1 to 2 and 4 to 5.

Position is kept until next pneumatic signal is applied.

Exhaust can be throttled.

Valve type P 520 121 G for manifolds displayed on page 2.7.2.5.

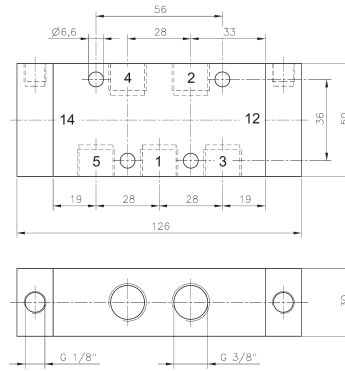

**P 520 101**

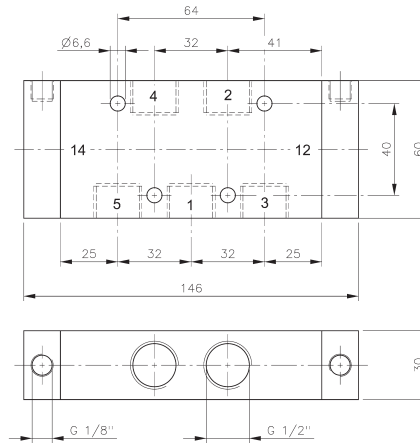

**P 520 121/P 520 121 NPT**

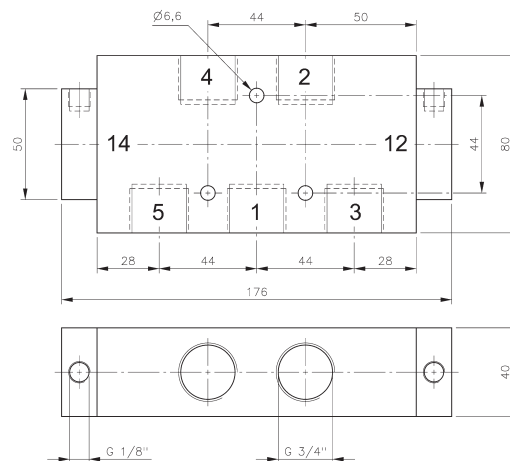

**P 520 181**

Type	Port size	Air flow	Operating press.	Actuating press.	Weight
P 520 101	G 3/8"	2250 l/min	1 - 10 bar	1,5 - 10 bar	0,48 kg
P 520 121	G 1/2"	3000 l/min	1 - 10 bar	1 - 10 bar	0,67 kg
P 520 181	G 3/4"	6000 l/min	1 - 10 bar	1 - 10 bar	1,22 kg
P 520 121 NPT	1/2" NPT	3000 l/min	1 - 10 bar	1 - 10 bar	0,67 kg

# P 53\_ 501 G/P 53\_ 701 G/P 53\_ 801

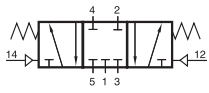

P 531 501 G  
P 531 701 G  
P 531 701 G NPT  
P 531 801

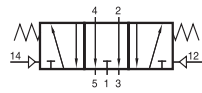

P 532 501 G  
P 532 701 G  
P 532 701 G NPT  
P 532 801

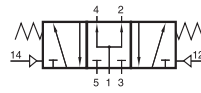

P 533 501 G  
P 533 701 G  
P 533 701 G NPT  
P 533 801

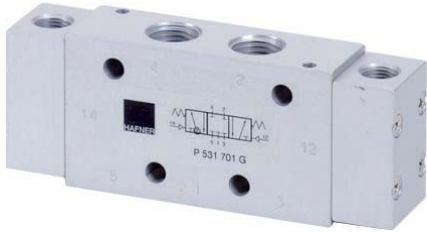

G-Series 501 G/701 G

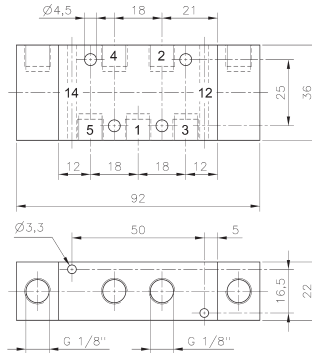

**P 53\_ 501 G**

Pneumatically actuated 5/3-way spool valve with spring return to middle position.

- Type 531 centre closed
- Type 532 centre exhausted
- Type 533 centre pressurised

When ordering please complete the type number by 1, 2 or 3 according to the type in need.

The G-Series valves offer the flexibility of in-line fitment as well as the option of being assembled on to a manifold as shown. Manifolds for valves type 501 G are displayed on page 2.7.2.2, manifolds for valves type 701 G are displayed on page 2.7.2.3.

Exhaust can be throttled.

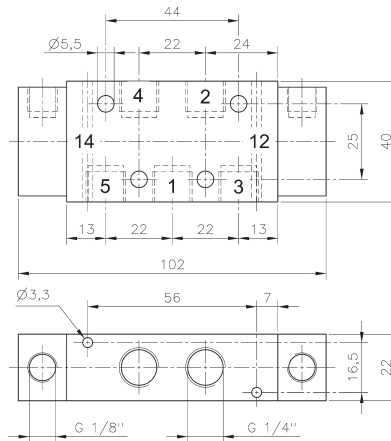

**P 53\_ 701 G/P 53\_ 701 G NPT**

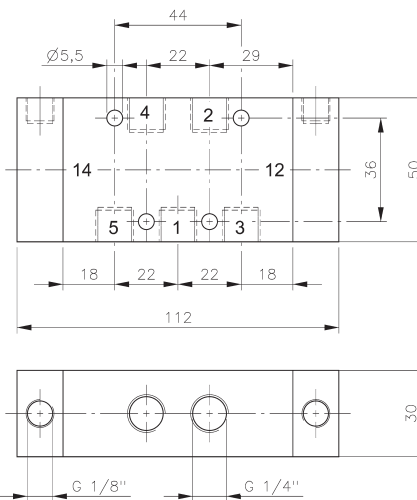

**P 53\_ 801**

Type	Port size	Air flow	Operating press.	Actuating press.	Weight
P 53_ 501 G	G 1/8"	650 l/min	1 - 10 bar	3 - 10 bar	0,20 kg
P 53_ 701 G	G 1/4"	1250 l/min	1 - 10 bar	3 - 10 bar	0,22 kg
P 53_ 801	G 1/4"	1450 l/min	1 - 10 bar	3 - 10 bar	0,44 kg
P 53_ 701 G NPT	1/4" NPT	1250 l/min	1 - 10 bar	3 - 10 bar	0,22 kg

# P 53\_ 101/P 53\_ 121/P 53\_ 181

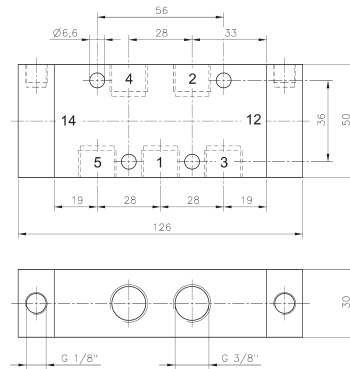
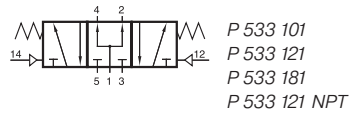
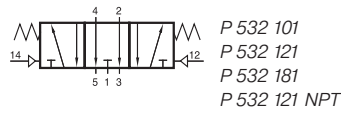
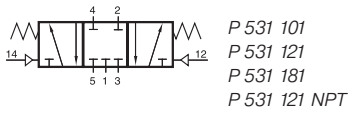

**P 53\_ 101**

Pneumatically actuated 5/3-way spool valve with spring return to middle position.

- Type 531 centre closed
- Type 532 centre exhausted
- Type 533 centre pressurised

When ordering please complete the type number by 1, 2 or 3 according to the type required.

Exhaust can be throttled.

Valve type P 53\_ 121 G for manifolds displayed on page 2.7.2.5.

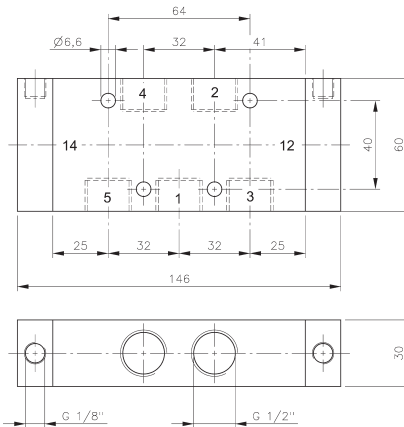

**P 53\_ 121/P 53\_ 121 NPT**

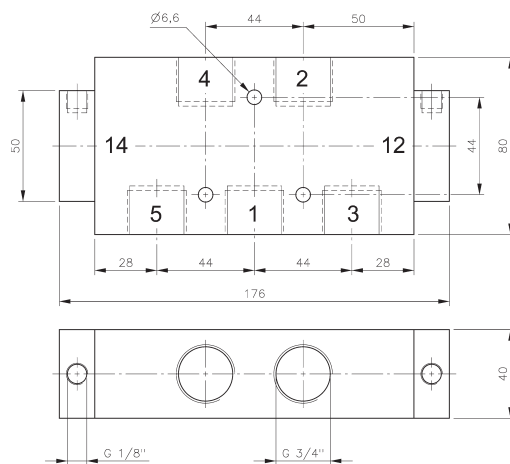

**P 53\_ 181**

Type	Port size	Air flow	Operating press.	Actuating press.	Weight
P 53_ 101	G 3/8"	2250 l/min	1 - 10 bar	3 - 10 bar	0,49 kg
P 53_ 121	G 1/2"	3000 l/min	1 - 10 bar	3 - 10 bar	0,69 kg
P 53_ 181	G 3/4"	6000 l/min	1 - 10 bar	3 - 10 bar	1,22 kg
P 53_ 121 NPT	1/2" NPT	3000 l/min	1 - 10 bar	3 - 10 bar	0,69 kg



# P 510 704/P 520 704/P 53\_ 704

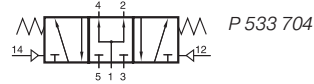
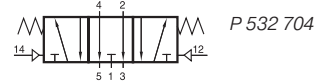
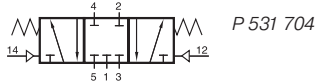
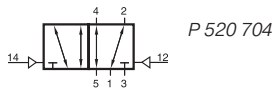
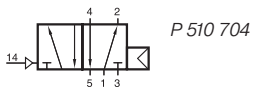

Pneumatically actuated 5/2-way and 5/3-way spool valves.  
All the ports are in the plate.

- |          |                    |         |
|----------|--------------------|---------|
| Type 510 | single pilot       | 5/2-way |
| Type 520 | double pilot       | 5/2-way |
| Type 531 | centre closed      | 5/3-way |
| Type 532 | centre exhausted   | 5/3-way |
| Type 533 | centre pressurised | 5/3-way |

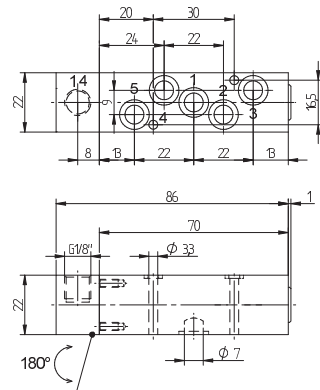

**P 510 704**

Manifolds are displayed on page 2.7.2.8.

Blanking plates are also available type BP 5 704.

Mounting screws and seals are included.

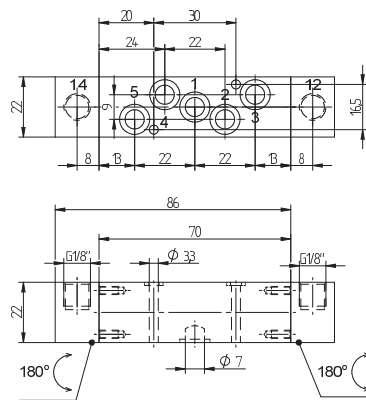

**P 520 704/P 53\_ 704**

Type	Function	Port size	Air flow	Operating press.	Actuating press.	Weight
P 510 704	5/2-way single pilot	Ø 7 mm	1250 l/min	2 - 10 bar	the same	0,20 kg
P 520 704	5/2-way double pilot	Ø 7 mm	1250 l/min	1 - 10 bar	2,5 - 10 bar	0,29 kg
P 53_ 704	5/3-way	Ø 7 mm	1250 l/min	1 - 10 bar	3 - 10 bar	0,29 kg

# VA 341/VA 361/VA 401 ES 341/ES 401

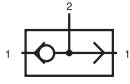

VA 341  
VA 361  
VA 401

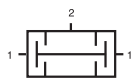

ES 341  
ES 401



### VA 341/VA 361/VA 401: OR-gate

The OR-gate has two inputs 1 and one output 2.

The shuttle valve is used when only one of two possible signals is required to pass on a signal.

Function: If one of two signal inputs are activated, an output signal on port 2 is present and the other input is blocked.

In case of pressurising both inputs at different pressure levels, the higher pressure is fed to port 2.

### ES 341/ES 401: AND-gate

The AND-gate has two inputs 1 and one output 2.

The dual-pressure valve is used when at least 2 signals are required before a signal is passed on.

Function: Only when both inputs are pressurised output 2 is pressurised.

If two different pressures are applied the lower pressure is fed to output 2.

In case of only one signal at one of the two ports 1, the output 2 is blocked.

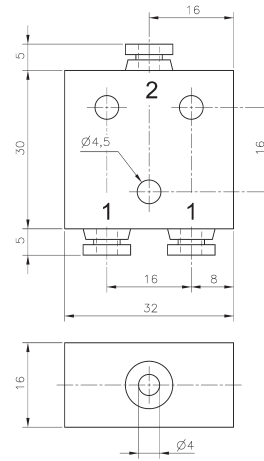

VA 341/ES 341

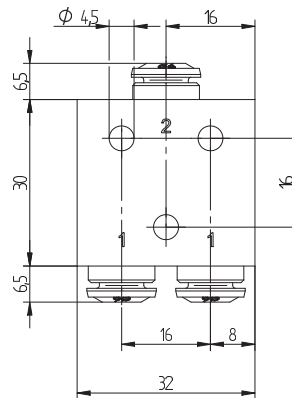

VA 361

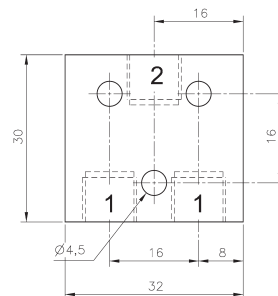
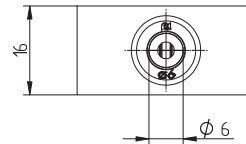

VA 401/ES 401

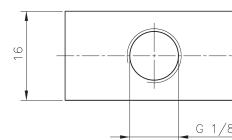

Type	Function	Port size	Air flow	Operating press.	Weight
VA 341	OR	pif 4 mm	280 l/min	1 - 10 bar	0,04 kg
VA 361	OR	pif 6 mm	280 l/min	1 - 10 bar	0,04 kg
VA 401	OR	G 1/8"	280 l/min	1 - 10 bar	0,04 kg
ES 341	AND	pif 4 mm	280 l/min	1 - 10 bar	0,04 kg
ES 401	AND	G 1/8"	280 l/min	1 - 10 bar	0,04 kg



# SE 501/SE 801/SE 8101/SE 121

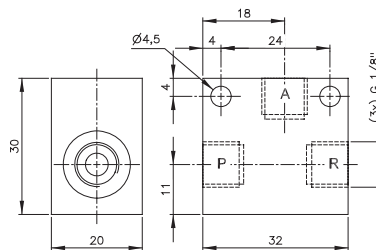
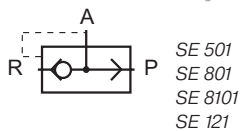

**SE 501**

Quick-exhaust valve which can also be used as non-return valve as well as or-gate.

If used as a non-return valve please plug port R. Open from P to A, closed from A to P.

If used as an or-gate connect pressure to P and R. Port A is outlet.

Temperature range: -20° C to +80° C

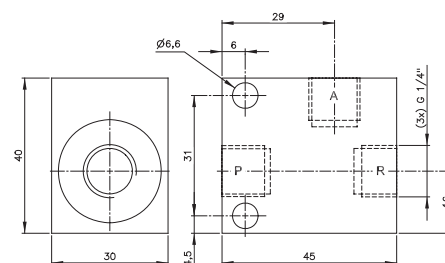

**SE 801**

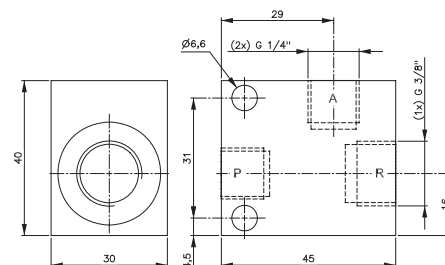

**SE 8101**

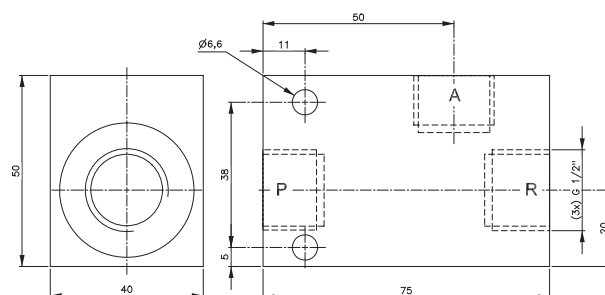

**SE 121**

Type	Port size A + P	Port size R	Air flow from A to R	Operating press.	Weight
SE 501	G 1/8"	G 1/8"	564 l/min	0,3 - 10 bar	0,06 kg
SE 801	G 1/4"	G 1/4"	1188 l/min	0,2 - 10 bar	0,18 kg
SE 8101	G 1/4"	G 3/8"	1188 l/min	0,2 - 10 bar	0,18 kg
SE 121	G 1/2"	G 1/2"	3600 l/min	0,5 - 10 bar	0,26 kg



# P 311 501 SR/P 411 701 SR

## P 411 701 SR NPT

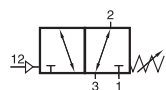

P 311 501 SR

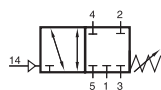
P 411 701 SR  
P 411 701 SR NPT

**P 311 501 SR** pneumatically actuated 3/2-way valve with mechanical spring return.

Valve can be used normally closed (pressure at port 1) and normally open (pressure at port 3).

Can also be used as 2/2-way valve.

Unused port to be closed with a silencer or plug.

**P 411 701 SR** pneumatically actuated 4/2-way valve with mechanical spring return.

Valve either blocks all ports or is open from 1 to 4 and from 3 to 2.

Port 5 is a vent port and should have a silencer installed, do not plug.



Valve can be used as an **adjustable pneumatic pressure switch**. By turning the hand-wheel the required minimum actuation pressure can be set. Adjustment is not independent from operation pressure.

Switch-on pressure differs from switch-off pressure due to a hysteresis of around 1.5 bar.

The hysteresis is the difference between the pressure point when the valve is opening (e.g. 5 bar) and closing (e.g. 3.5). The 1.5 bar hysteresis is just a reference point as it is depending on the friction force.

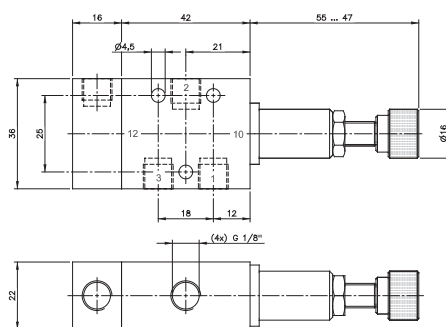
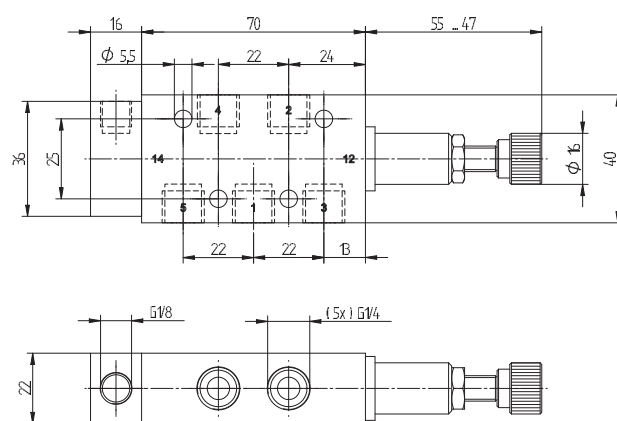
The proportion between the friction force and the force of the air is changing when the air pressure increases. Therefore the hysteresis is getting smaller when the set actuating pressure increases.

**P 311 501 SR****P 411 701 SR/P 411 701 SR NPT**

Type	Port size	Air flow	Operating press.	Regulating range act. press.	Max. act. press.	Weight
P 311 501 SR	G 1/8"	650 l/min	1 - 10 bar	3 - 6 bar	10 bar	0,16 kg 
P 311 501 SR 02	G 1/8"	650 l/min	1 - 10 bar	5 - 8 bar	10 bar	0,16 kg
P 311 501 SR 03	G 1/8"	650 l/min	1 - 10 bar	2 - 4 bar	10 bar	0,16 kg
P 411 701 SR	G 1/4"	1250 l/min	1 - 10 bar	3 - 6 bar	10 bar	0,21 kg 
P 411 701 SR NPT	1/4" NPT	1250 l/min	1 - 10 bar	3 - 6 bar	10 bar	0,21 kg

# ERV 701/ERV 121

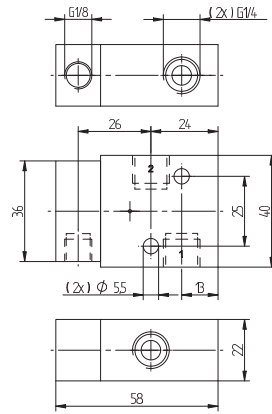
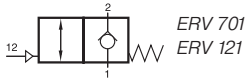

**ERV 701**

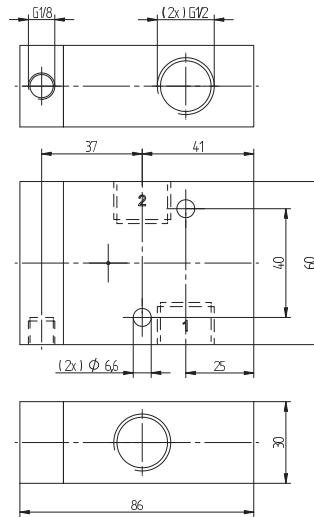

**ERV 121**

Pilot operated non-return valve.

Port 1 is blocked in basic position, but port 2 can exhaust through port 1.

When a pilot signal is applied to port 12, the valve opens from 1 to 2.

Valve can be used to lock the air in a cylinder in case of loss of air pressure.

Cylinder in movement:

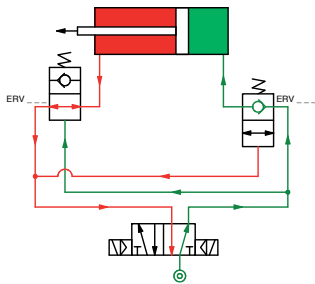

Pressure loss:

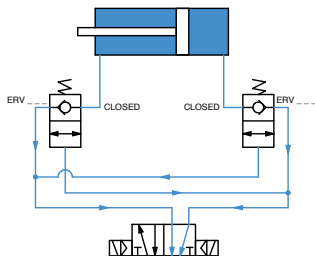

Type	Port size 1 and 2	Port size 12	Air flow	Operating press.	Weight
ERV 701	G 1/4"	G 1/8"	1250 l/min	1 - 10 bar	0,14 kg
ERV 121	G 1/2"	G 1/8"	3000 l/min	1 - 10 bar	0,45 kg



# DSV-1/8 / DSV-1/4 / DSVH-1/8 / DSVH-1/4

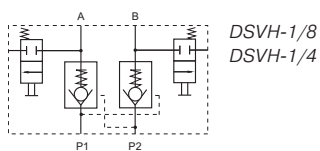
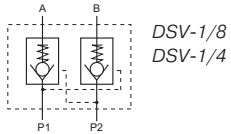

Pressure holding valves to hold a double acting actuator at the current position in case of pressure failure.

The valve consists of two non-return valves which will be unlocked by pressurising port P1 or P2.

Installation between pilot valve and actuator.

In case of pressure failure, the valve is locking the air in the gripper and thereby it does not lose its load.

Type DSVH with manual exhaust function. The user can exhaust the actuator manually by pushing the manual exhaust buttons.

Inner parts are made of brass and POM, seals are made of NBR.

The valve is often used in combination with pneumatic grippers.

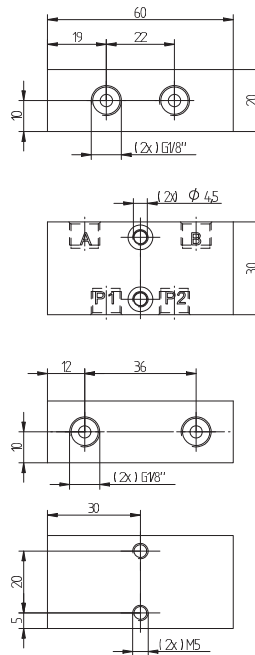

**DSV-1/8**

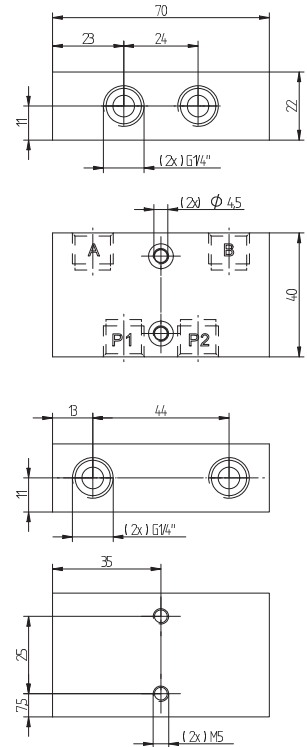

**DSV-1/4**

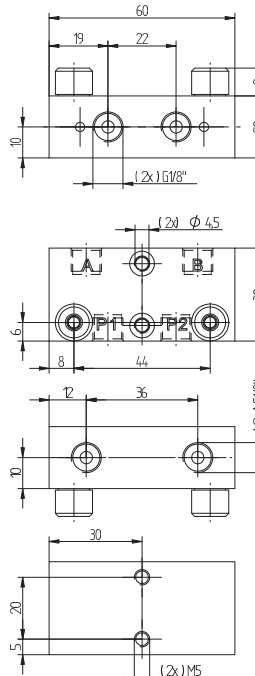

**DSVH-1/8**

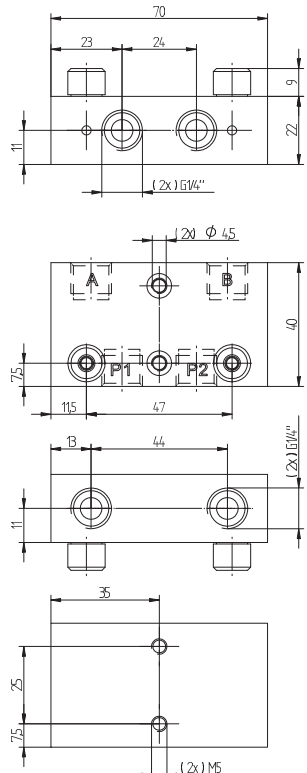

**DSVH-1/4**

Type	Port size	Air flow P to A/B	Air flow A/B to P	Operating press.	Weight
DSV-1/8	G 1/8"	230 l/min	360 l/min	1 - 10 bar	0,10 kg
DSV-1/4	G 1/4"	650 l/min	1000 l/min	1 - 10 bar	0,10 kg
DSVH-1/8	G 1/8"	230 l/min	360 l/min	1 - 10 bar	0,10 kg
DSVH-1/4	G 1/4"	650 l/min	1000 l/min	1 - 10 bar	0,10 kg

# PFF 520 701/PFFR 520 701

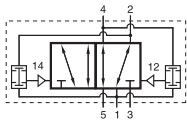

PFF 520 701

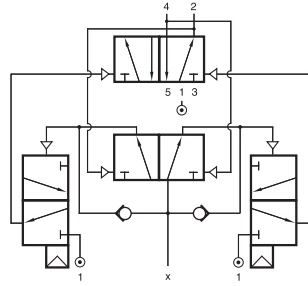

PFFR 520 701



Valves to generate oscillating movements for devices where continuous cycling is required, e.g. shaking, hammering, scraping, wiping, dipping etc.

**Oscillating valve type PFF 520 701:**

When compressed air is applied to port 1, the outlet ports 2 and 4 are alternately supplied with compressed air. The valve always moves the position as soon as the cylinder has reached the end position and a back pressure is applied to the valve.

**Flip-Flop valve type PFFR 520 701:**

The PFFR is a bistable 5/2-way valve, which is operated by only one pilot port. When a signal is applied to pilot port X, the valve is switching the position. It will remain in this position even if the signal is taken away. When the pilot signal is applied to port X again, the valve will switch the position again.

The speed of the operated cylinder and thus the frequency can be adjusted by adding flow regulators to the exhaust ports 3 and 5 of the valve. Please ask for SVE-1/4.

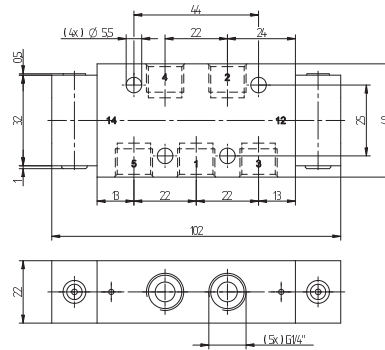

PFF 520 701

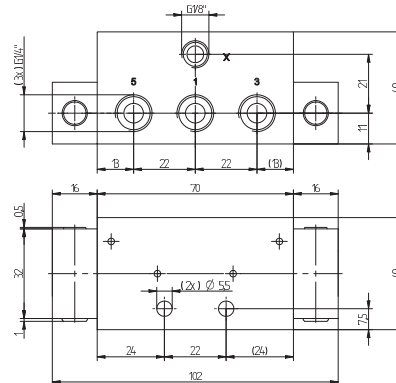

PFFR 520 701



SVE-1/4

Type	Port size	Air flow	Operating press.	Weight
PFF 520 701	G 1/4"	1250 l/min	2 - 10 bar	0,22 kg
PFFR 520 701	G 1/4"	1250 l/min	2 - 10 bar	0,40 kg

# DR 501/DR 801/DR 101 D 501/D 801/D 101

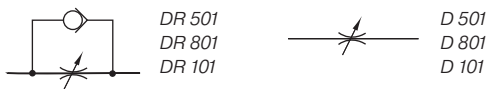

Block form flow regulator.

### Type DR

uni-directional block form flow regulator.

Air streaming in the direction of the throttle can be regulated by turning the spindle. In the opposite direction air streams unthrottled.

### Type D

bi-directional flow regulator. Air is regulated in both directions.

The throttle can be adjusted very precisely along the entire regulation range.

Adjustment can be locked.

Suitable for wall and panel mounting.  
Nut is included.

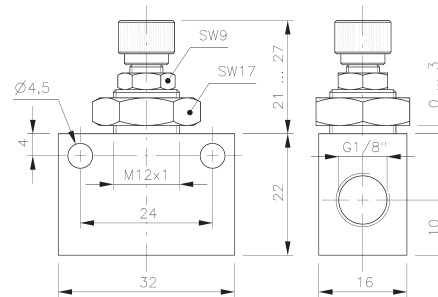
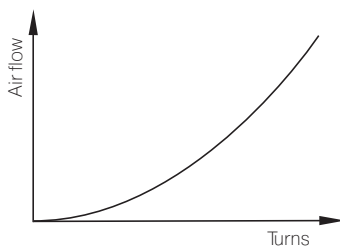

**DR 501/D 501**

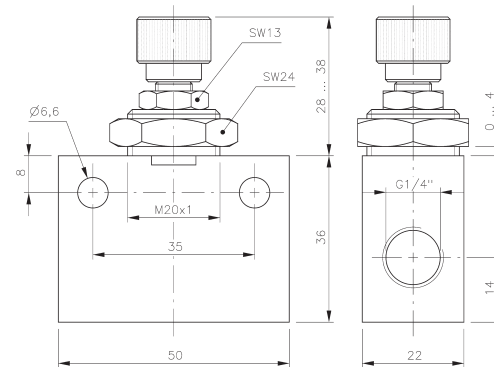

**DR 801/D 801**

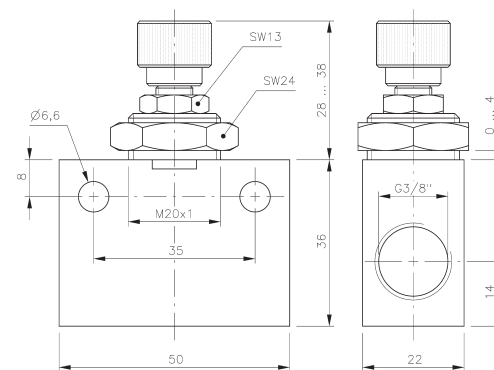

**DR 101/D 101**

Type	Port size	Air flow*	Airflow in opposite direction*	Operating press.	Weight	
D 501	G 1/8"	450 l/min	450 l/min	0,5 - 10 bar	0,04 kg	❄️
D 801	G 1/4"	1150 l/min	1150 l/min	0,5 - 10 bar	0,13 kg	❄️
D 101	G 3/8"	1450 l/min	1450 l/min	0,5 - 10 bar	0,13 kg	
DR 501	G 1/8"	450 l/min	450 l/min	2 - 10 bar	0,04 kg	⚠️❄️
DR 801	G 1/4"	1150 l/min	1150 l/min	2 - 10 bar	0,13 kg	⚠️❄️
DR 101	G 3/8"	1450 l/min	1450 l/min	2 - 10 bar	0,13 kg	⚠️

\* Values at 10 bar inlet pressure and without back pressure.

# D 181 G/D 181 0\_



Block form flow regulator, bi-directional.  
Air is regulated in both directions.

Adjustment can be locked by a socket screw.  
7 coloured rings indicate the adjustment.

The flow regulator can either be used in-line or on a manifold plate. The following manifold sizes are available:

- D 181 02 2 stations, including flow regulators
- D 181 03 3 stations, including flow regulators

Temperature range: 0°C to 120°C.

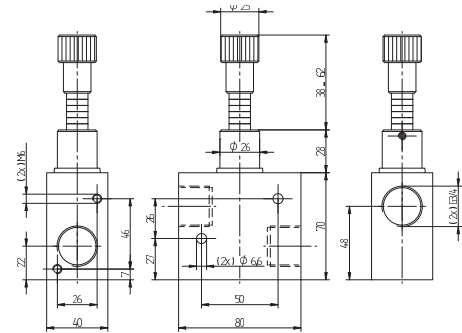

**D 181 G**

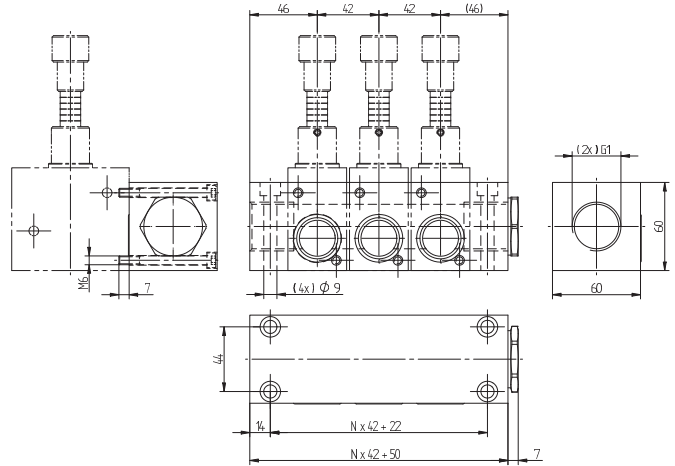

**D 181 0\_**

Type	Port size	Air flow*	Operating press.	Weight
D 181 G	G 3/4"	6000 l/min	0 - 10 bar	0,75 kg

\* Values at 10 bar inlet pressure and without back pressure.



# P 310 304/P 311 304 P 320 304/P 322 304/RP 3 344

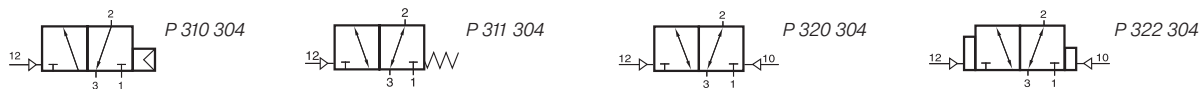

Pneumatically actuated 3/2-way spool valves.  
To be assembled to plate RP 3 344.

Four different versions are offered:

- P 310 304 valve with air-spring return
- P 311 304 valve with mechanical spring return  
Pressure applied to port 1 = YES-function  
Pressure applied to port 3 = NOT-function
- P 320 304 double pilot valve
- P 322 304 double pilot valve dominating at port 12

For P 310 304 the operating and actuating pressure should be at the same level.

RP 3 344 is designed for carrying one 3/2-way valve type P 310 304, P 311 304, P 320 304 or P 322 304.  
The plate is equipped with 5 push-in fittings for 4 mm tube.

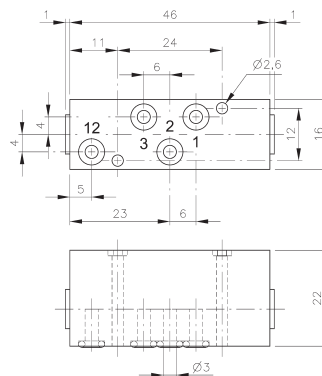

**P 310 304/P 311 304**

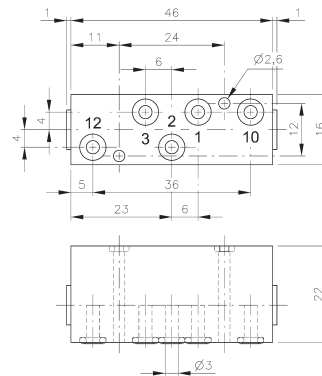

**P 320 304/P 322 304**

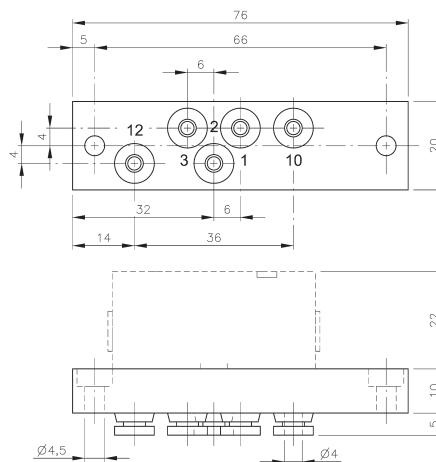

**RP 3 344**

Type	Port size	Air flow	Operating press.	Actuating press	Weight
P 310 304	Ø 3 mm	280 l/min	2 - 10 bar	the same	0,04 kg
P 311 304	Ø 3 mm	280 l/min	2 - 10 bar	3 - 10 bar	0,04 kg
P 320 304	Ø 3 mm	280 l/min	2 - 10 bar	2,5 - 10 bar	0,04 kg
P 322 304	Ø 3 mm	280 l/min	2 - 10 bar	2,5 - 10 bar	0,04 kg
RP 3 344	pif 4 mm				0,04 kg

# P 510 304/P 511 304 P 520 304/P 522 304/RP 5 344

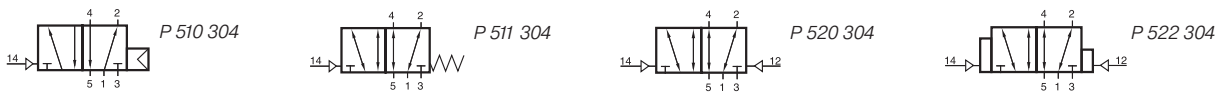

Pneumatically actuated 5/2-way spool valves.  
To be assembled to plate RP 5 344.

Four different versions are offered:

- P 510 304 valve with air-spring return
- P 511 304 valve with mechanical spring return
- P 520 304 double pilot valve
- P 522 304 double pilot valve dominating at port 14

5/3-way valves are available on request.

For P 510 304 the operating and actuating pressure should be at the same level.

RP 5 344 is designed for carrying one piece 5-way valve type P 510 304, P 511 304, P 520 304 or P 522 304.

3/2-way valves can also be assembled to that plate.  
The plate is equipped with 7 push-in fittings for 4 mm tube.

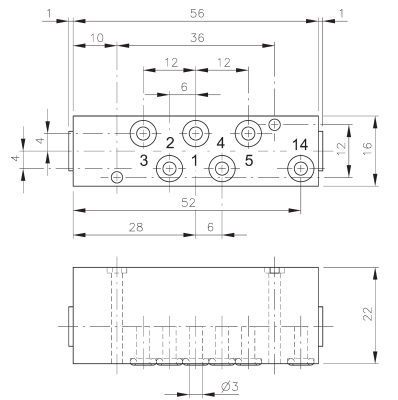

**P 510 304/P 511 304**

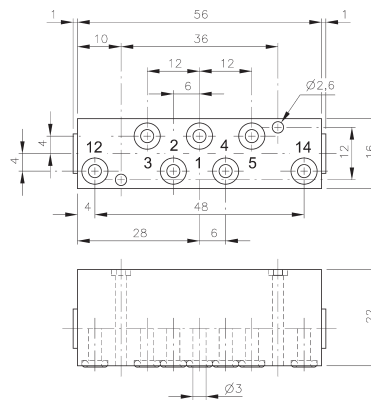

**P 520 304/P 522 304**

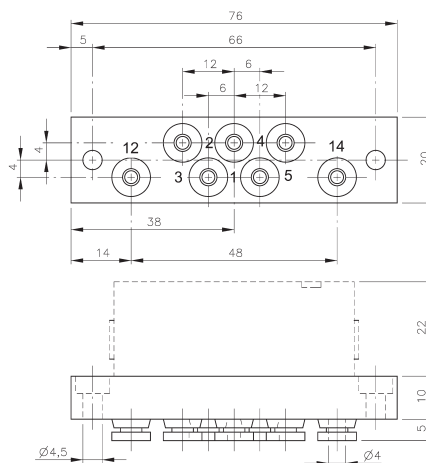

**RP 5 344**

Type	Port size	Air flow	Operating press.	Actuating press	Weight
P 510 304	Ø 3 mm	280 l/min	2 - 10 bar	the same	0,06 kg
P 511 304	Ø 3 mm	280 l/min	2 - 10 bar	3 - 10 bar	0,06 kg
P 520 304	Ø 3 mm	280 l/min	2 - 10 bar	2,5 - 10 bar	0,06 kg
P 522 304	Ø 3 mm	280 l/min	2 - 10 bar	2,5 - 10 bar	0,06 kg
RP 5 344	pif 4 mm				0,04 kg

# VA 304/ES 304/RP 2 344

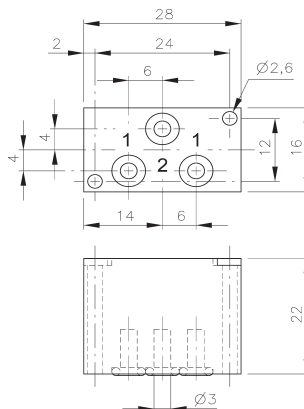
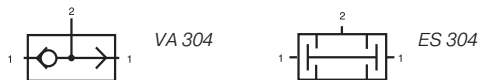

**VA 304/ES 304**

### VA 304: OR-gate

The OR-gate has two inputs 1 and one output 2.

The shuttle valve is used when only one of two possible signals is required to pass on a signal.

Function: If one of two signal inputs are activated, an output signal on port 2 is present and the other input is blocked.

In case of pressurising both inputs at different pressure levels, the higher pressure is fed to port 2.

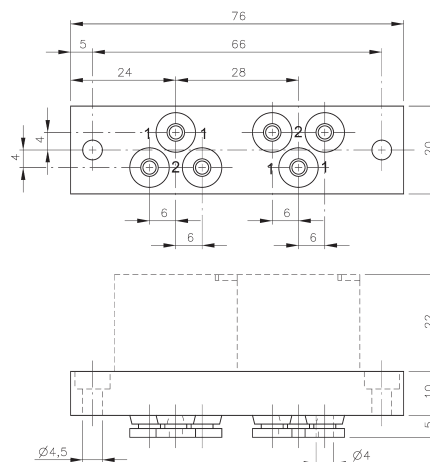

**RP 2 344**

### ES 304: AND-gate

The AND-gate has two inputs 1 and one output 2.

The dual-pressure valve is used when at least 2 signals are required before a signal is passed on.

Function: Only when both inputs are pressurised output 2 is pressurised.

If two different pressures are applied the lower pressure is fed to output 2.

In case of only one signal at one of the two ports 1, the output 2 is blocked.

Both elements can be assembled to RP 2 344.  
 Plate can carry 2 pieces AND- or OR-gates.  
 Both types can be mixed on the plate. The plate is equipped with 6 push-in fittings for 4 mm tube.

Type	Function	Port size	Air flow	Operating press.	Weight
VA 304	OR	Ø 3 mm	280 l/min	1 - 10 bar	0,03 kg
ES 304	AND	Ø 3 mm	280 l/min	1 - 10 bar	0,03 kg
RP 2 344	plate	pif 4 mm			0,04 kg

